

For highway Guard Rail (YC-HSB, SB5-B)

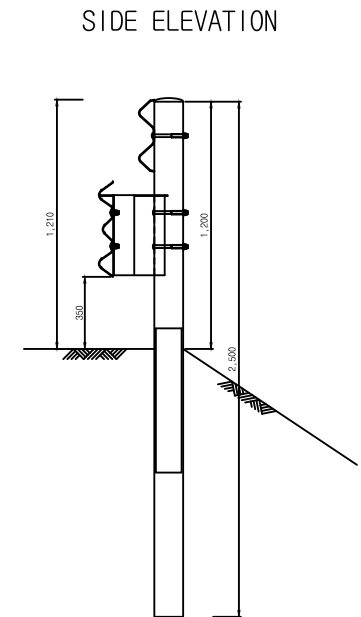

(4M/Per span)

(4M/Per span)

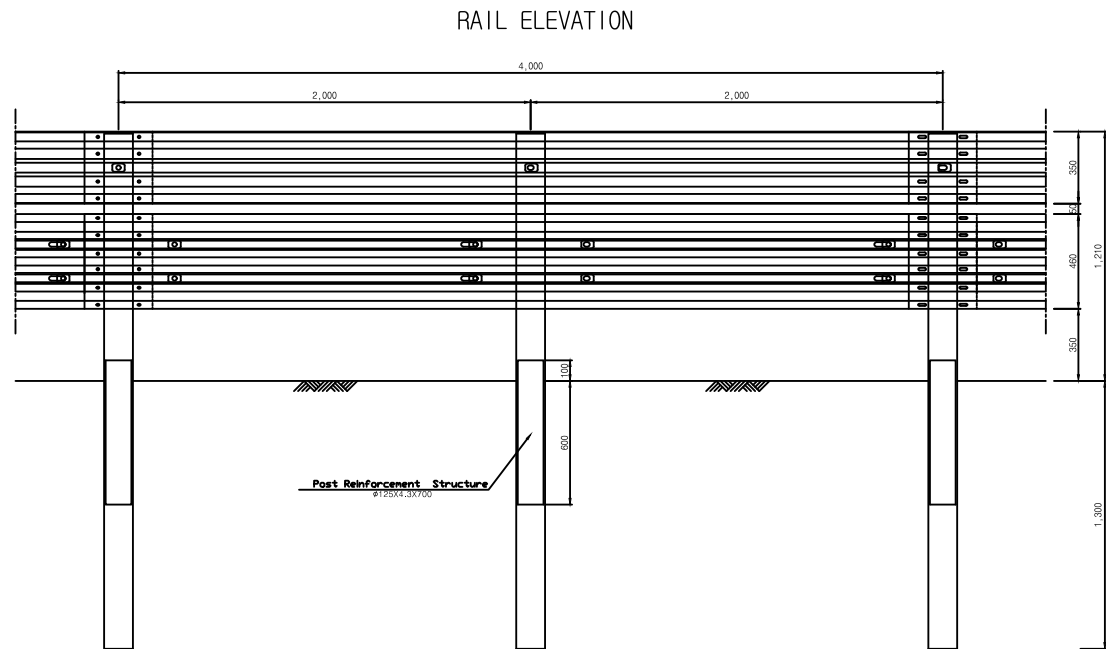
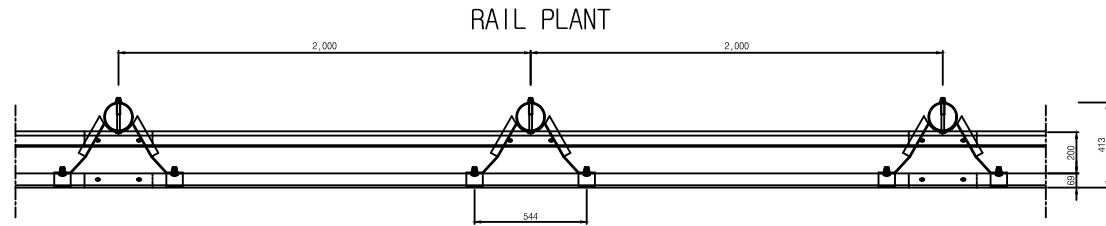

SUNGWON
ENC CO., LTD

5, 1st floor, Yeonsudongsan-ro 7-gil, Chungju-si,
Chungcheongbuk-do (Yeonsu-dong)
TEL 043-351-7717
F A X 0504-038-9103

Product Name	Dimension	Unit	Quantity	Remarks	Product Name	Dimension	Unit	Quantity	Remarks
Guard Rail	3.2x460x4,330	EA	1	SS275	Guard Rail	4.0x350x4,330	EA	1	SS275
Post	φ139.8x4.5x2,500	EA	2	SGT275	fixing B/N	φ18x40	EA	8	
Post Reinforcement Structure	φ125x4.3x700	EA	2	SGT275	Connection B/N	φ16x33	EA	20	
block out	4.3x624x389	EA	2	SS275	Mounting B/N	φ19x180	EA	6	
Square washer	40x60	EA	20	SS275	CAP	φ139.8	EA	2	SS275

For highway Guard Rail (YC-HSB, SB5-B)

Guard Rail

RAIL ELEVATION

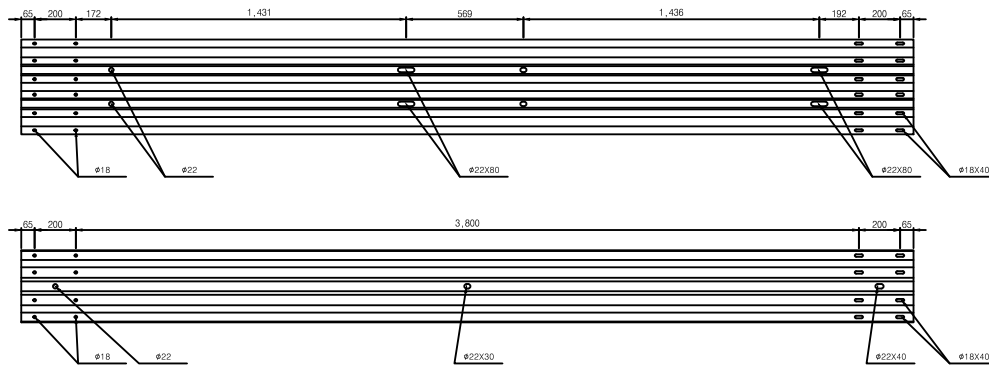

SIDE ELEVATION

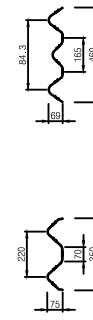

Post

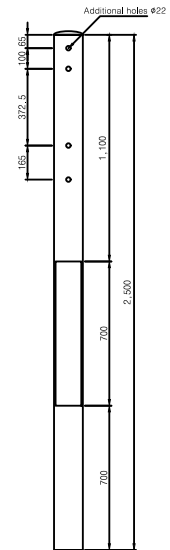
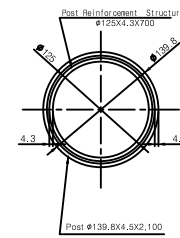

Detailed BOLT/NUT

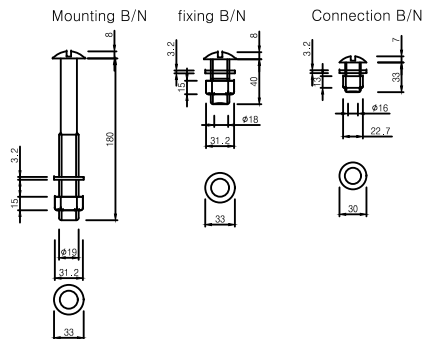

CAP

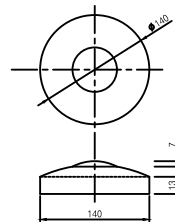

Square washer

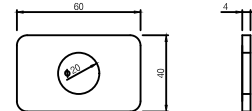

block out

