

고속구간용 차량방호울타리(1) : SU-YC-HSB3-B-01

노측용(SU-YC-HSB,SB3-B)

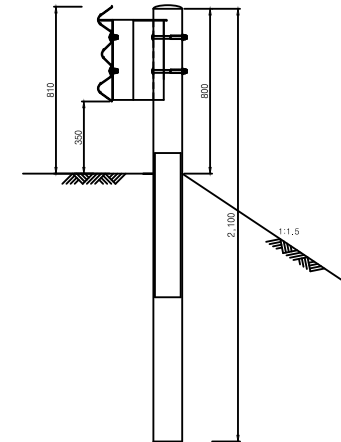
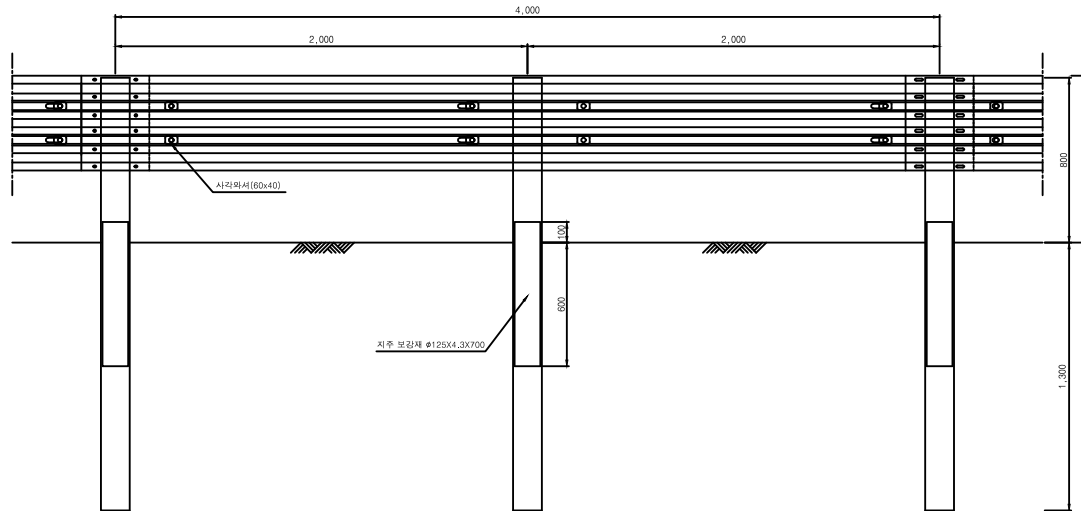
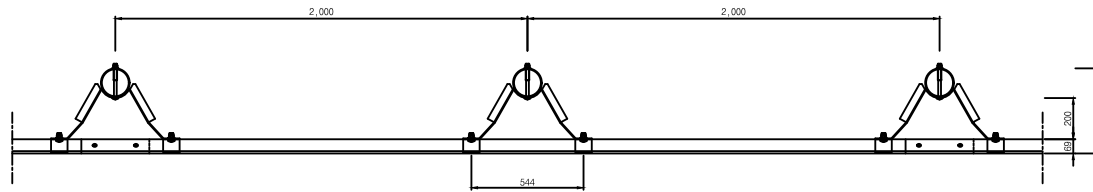

(4M/1관라)

(4M/1관라)

주식회사
성원건설산업

충청북도 충주시 연수동산로7길 5, 1층(연수동)
대표전화 043-851-7717
팩 스 0504-038-9103

품명	규격	단위	수량	비고	품명	규격	단위	수량	비고
가드레일	3.2x460x4,330	EA	1	SS400	취부볼트	$\phi 19 \times 180$	EA	4	용융아연도금
지주	$\phi 139.8 \times 4.5 \times 2,100$	EA	2	STK400	고정볼트	$\phi 18 \times 40$	EA	8	용융아연도금
지주보강재	$\phi 125 \times 4.3 \times 700$	EA	2	STK400	연결볼트	$\phi 16 \times 33$	EA	12	용융아연도금
블럭아웃	4.3x624x389	EA	2	SS400	CAP	$\phi 139.8$ 용	EA	2	SS400
사각와셔	40x60	EA	8	SS400					

고속구간용 차량방호울타리(1) : SU-YC-HSB3-B-01

노측용(SU-YC-HSB, SB3-B)

가드레일 상세도

정면도

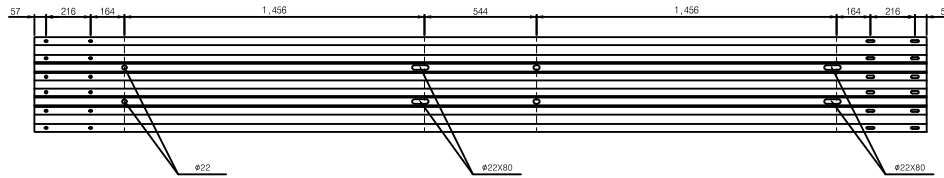

측면도

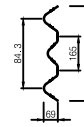

지주상세도

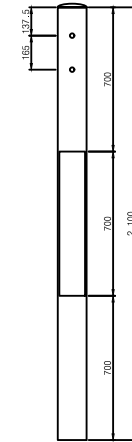
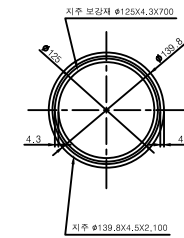

BOLT/NUT 상세도

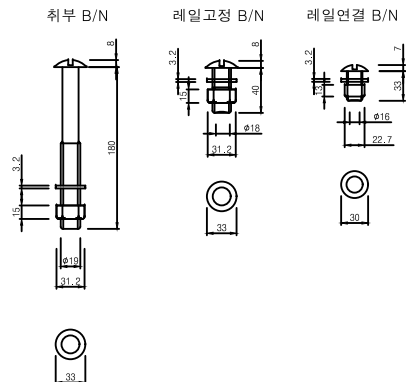

지주 덮개 상세도

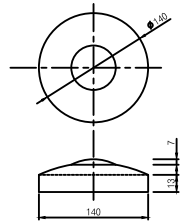

슬라이딩 워셔

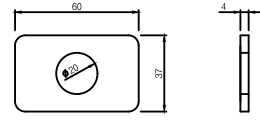

블럭아웃상세도

